

# MKP-150, MKP-151

## 2-Way Wireless Keypad



# Visonic®

## User's Guide

### 1. INTRODUCTION

#### NOTE: RELEVANT TO POWERMAX+ VERSION B AND ABOVE

The MKP-150 / MKP-151 (different color) operates using two-way encrypted coded transmission and provides aural and visual indications. For each PowerMax+ control panel, a maximum of two MKP-150/MKP-151 keypad devices may be enrolled.

The MKP-150/MKP-151 may be operated either by AC power supply or by battery power. If AC power is used, the device operates continuously and the system status is constantly updated. If powered by batteries, the keypad enters sleep mode 15 sec after last key press. The keypad immediately becomes operational again upon pressing of any key.

**Note:** In the event of an AC power failure, the MKP-150/MKP-151 operates on batteries as described above.

The device enables the user to arm/disarm the alarm system, to initiate emergency/fire/panic alarms and to turn lighting devices on and off.

The main features of the MKP-150/MKP-151 are:

- Status, alarm memory, and trouble data retrieval from PowerMax+.
- Automatic reporting to PowerMax+ of low battery voltage, AC failure, tamper.
- Visual indications by red/green/amber LED and LCD display.
- Keypad and LCD backlighting activation.
- Light dim / brightness
- Various audible signals sounded by the speaker in response to specific actions.
- Automatic supervision messages.

- Diagnostic test of PowerMax+.
- Two long-life 3 Volt Lithium batteries.
- Wall mounting.
- Friendly programming.

The Power (green) LED lights when operated using AC power. The Trouble (amber) LED lights if a "trouble" state is currently detected within the PowerMax+. The Chime (green) LED lights when the chime function is active. The Arm (red) LED lights when the system is in armed state (away mode), or flashes (home mode).

A periodic supervision message is transmitted, at regular intervals, from the MKP-150/MKP-151 to the PowerMax+ control panel. This ensures active participation of the MKP-150/MKP-151 in the system.

Operating power is obtained from two 3 Volt Lithium batteries, or by AC. A weak battery causes a "low battery" message to be sent to the PowerMax+.

A Screen Saver appears on the display (if enabled by the installer on the PowerMax+ unit) when no key is pressed for more than 30 seconds. The display reads "POWERMAX" and the LEDs do not light (to prevent an intruder of knowing the system status). The normal display returns after pressing the OFF button followed by entering user code (**Refresh by Code**) or after pressing any key (**Refresh by Key**), depending on the PowerMax+ settings of the installer. If **Refresh by Key** was selected, the first key press (except for Fire and Emergency) causes the normal display to return while a second press performs the key function. In the case of the Fire and Emergency keys, the first key press causes the normal display to return and also performs the Fire/Emergency function.

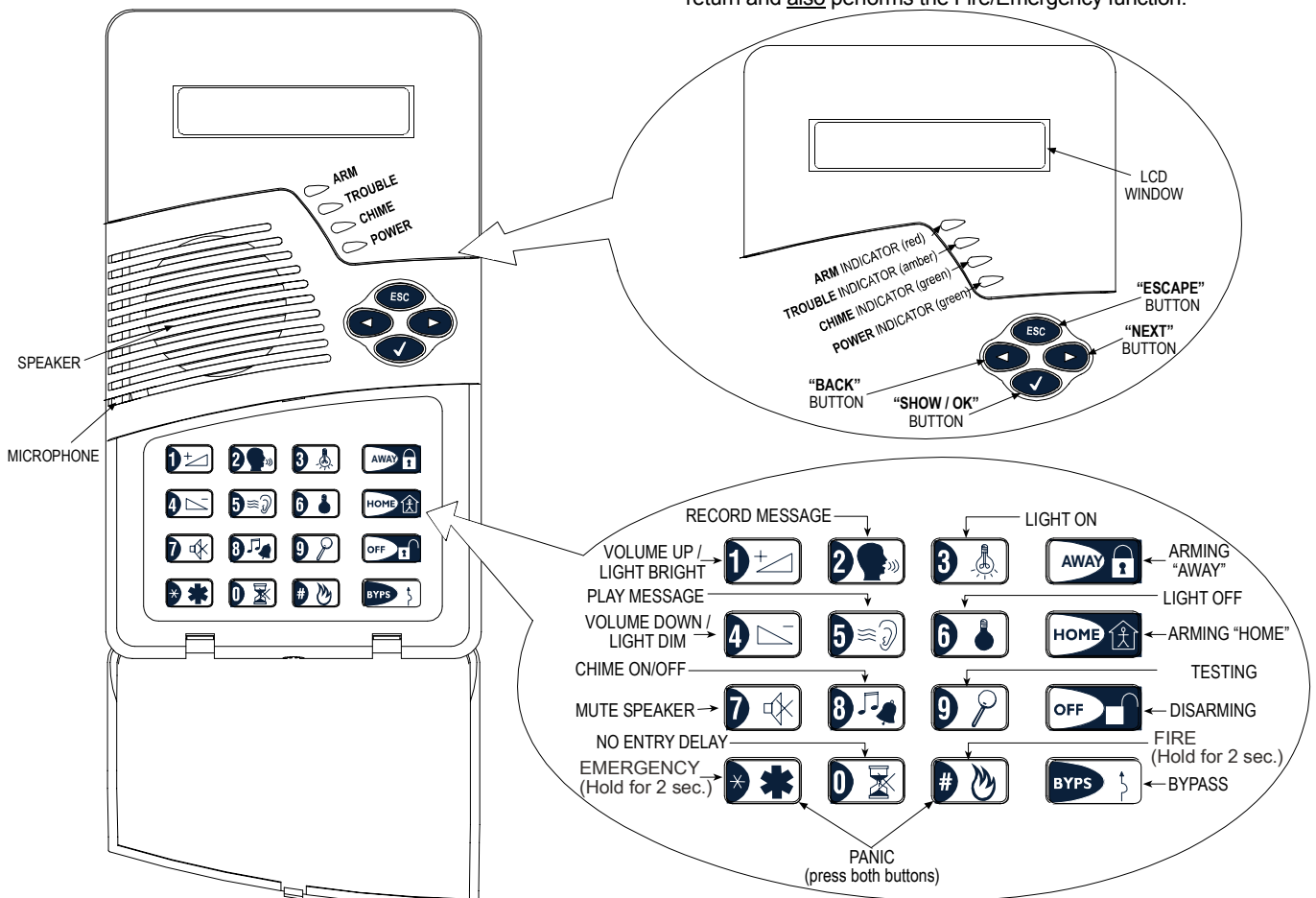

## 2. SPECIFICATIONS

### ELECTRICAL

**Battery Power Source:** Two 3 Volt Lithium batteries, type CR123A (Sanyo or equivalent).

**Battery Life Expectancy:** 2 years (for typical use).

**AC Power Supply (optional):** Plug-in transformer.

120 VAC, 60 Hz / 9 VAC, 0.35 A min. (in the U.S.A.)

230 VAC, 50 Hz / 9 VAC, 0.35 A min.

**UL installation:** Use transformer type OH-35048AT, manufactured by Oriental Hero Electrical Factory.

**In Europe and elsewhere:** Use only Safety National Approved AC adapter, mains-to-9 VAC, 0.35 A min.



**AC Current Drain:** Approx. 30 mA standby, 300 mA max. at full load.

**Display:** Single line, backlit 16-character LCD and 4 LED indicators.

**Control Functions:** Home Arming, Away Arming, Bypass, Disarming, Latchkey, Light ON / OFF, Light Dim / Brightness, Recording, Forced Arming, Panic, Fire and Emergency calls.

**Sleep Mode:** Used to minimize current consumption. The unit enters sleep mode 15 seconds after last use (applies only when using batteries or when there is a power failure).

**Supervision:** A periodic supervision message (programmable) is transmitted automatically once every 15 minutes (Europe), once every 60 minutes (USA), or according to the local standards. This function can be disabled.

**Panic Alarm Message:** Activated by simultaneously pressing the  and  keys.

**Tamper Switch:** Normally closed. A tamper signal is transmitted in three ways: when the MKP-150/MKP-151 case is opened; when the keypad assembly is separated from the bracket; or if the MKP-150/MKP-151 unit is ripped from the wall.

**Compliance with Standards:** FCC part 15, EN 50131-1 Grade 2 Class II, TS 50131-3 and Directive 1999/5/EC

### RF SECTION

**Operating Frequencies:** 315 MHz (in USA & Canada) or other UHF channels per local requirement in the country of use.

**Receiver Type:** Super-heterodyne, fixed frequency

**Receiver Range:** 600 ft (180 m) in open space

**Antenna Type:** Spatial

**Coding:** Two-way wireless protocol

### ENVIRONMENTAL

**For indoor use only.**

**Operating Temp. Range:** 0°C to 49°C (32°F to 120°F)

**Storage Temp. Range:** -20°C to 60°C (-4°F to 140°F)

**Humidity:** 85% relative humidity, @ 30°C (86°F)

### PHYSICAL

**Dimensions:** 172 x 99 x 39 mm (6 7/8 x 3 15/16 x 1 9/16 in.)

**Weight:** 375 g. (13 oz)

**Mounting:** Surface-mounted

**Color:** Light gray

## 3. INSTALLTION AND WIRING

Perform the procedures as illustrated in the following Figures.

**Note:** Mount the unit inside the secured premises, in a location providing optimum signal reception from the PowerMax+ unit, (refer to Installing Wireless Systems Installation Guide – The Right Way, document no. DE2000W, for further details).

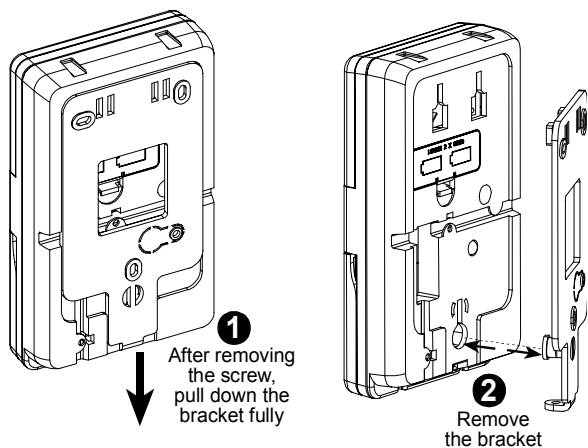
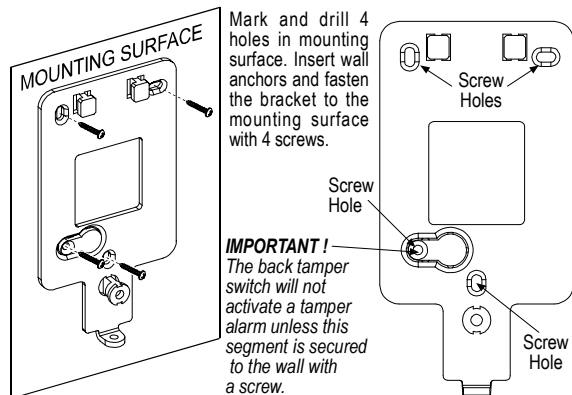

Figure 2: Bracket Removal



**Note:** Leave at least 3 cm (1.25 in.) free space around the bracket.

Figure 3: Bracket Mounting

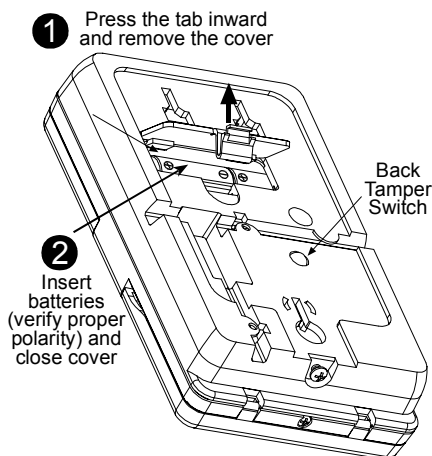

Figure 4: Battery Insertion

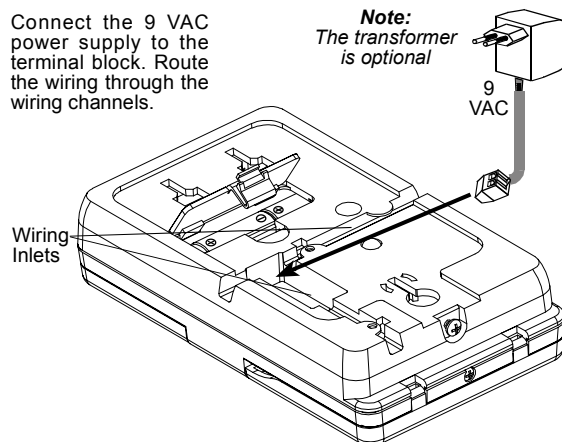

Figure 5: Wiring

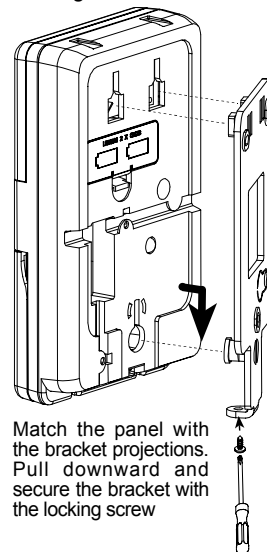

Figure 6: Panel Mounting

## 4. ENROLLING/DELETING THE KEYPAD FROM THE POWERMAX+ MEMORY

To enroll all the MKP-150/MKP-151 functions (for complete list see *PowerMax+ Installer Guide*), enter the PowerMax+ Installer Mode from the PowerMax+ keypad, and proceed as shown in the following illustration.

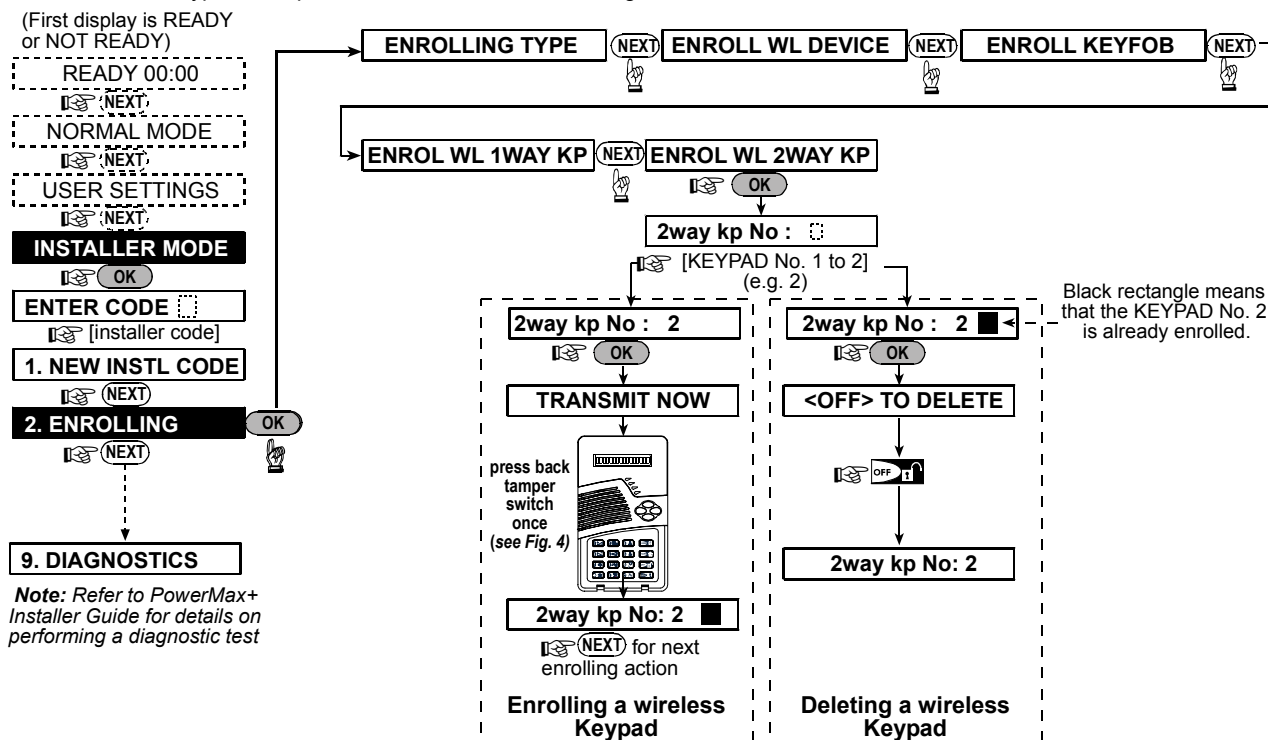

Figure 7: Enrolling / Deleting a MKP-150/MKP-151 Device from PowerMax+ Memory

## 5. DEFINING MKP-150/MKP-151 PARAMETERS

### 5.1 Installer Menu Functions

**Important:** All installer settings affect only the specific keypad on which the settings were performed.

The Installer menu enables you to perform the following functions:

#### SUPERVISION

The keypad transmits supervision reports periodically to the PowerMax+.

The options are: **15 minutes**, **1 hour** and **disable**.

**Note:** In FCC installations, the keypad must be set to 1 hour.

#### PIEZO BEEP

Here you determine whether warning beeps will sound or be muted during exit and entry delays.

Options: **enable beeps**, **off when home** and **disable beeps**.

#### BACK LIGHT

The keypad and LCD back light can be activated in one of two ways:

- **By key press:** back light is activated for ten seconds by a long press (2 sec) of any key.
- **Always on:** back light remains on continuously. (Enabled only when the unit is connected to the AC supply.)

The options are: **OFF after 10s** and **always ON**.

#### JAM DETECTION

**Note:** This feature is enabled only with PowerMax+ version 3.3.14 and above.

Here you determine whether jamming (interfering transmissions on the radio channel used by the system) will be detected.

The options are: **UL 20/20**, **EN 30/60**, **class 6 (30/60)**, or **disable**.

#### RECORD SPEECH

This mode allows you to record up to 5 custom zone names.

#### SERIAL NUMBER

Enables reading the system serial number for support purposes only.

### 5.1.1 To Set Supervision Time

Make sure the system is not in Arm mode.

The installer's menu is accessible only to those who know the installer's code, which is **9→9→9→9** by factory default.

A. Press the next button (▶) repeatedly until the display reads:

**INSTALLER MODE**

B. Press the Show / OK button (√). The display should read:

**ENTER CODE : [ ] [ ] [ ] [ ]**

**Note:** For PowerMax+ that has two installer codes, the default **INSTALLER** code is 8888 and the default **MASTER INSTALLER** code is 9999.

C. Enter the installer code. The display will change to:

**SUPERVISION**

D. Press <√>.

E. Press <▶> repeatedly to select one of the available options.

F. Press <√> to set the selected option.

### 5.1.2 To Activate the Recording Mode

A. Upon gaining access to the installer menu (see section 5.1.1 A to C), the display will read "**SUPERVISION**".

B. Press <▶>; **RECORD SPEECH** is displayed.

C. Press <√>. The display will change to:

**USER TERM #1**

**Note:** User Term refers to the name assigned to the recorded zone.

**Note:** It is recommended to assign custom names that are identical to the custom names defined in the PowerMax+.

D. Press the [ ] key until this is displayed briefly:

**RECORD A MESSAGE**

Immediately thereafter, the display will change to:



- E. Do not release the **2** key and start talking immediately (for example, living room or library), while facing the front panel. The dark square boxes will slowly disappear one by one, from right to left. When the last one disappears (5 seconds later) the following message will be displayed:



- F. Release the **2** key. To check the message, press the **5** key and listen to the playback.  
 G. Press **<▶>**. The display will change to:



- H. Repeat the procedure for User Terms #2 - #5 to record the names of zones 2 - 5.

### 5.1.3 To Enable/Disable Piezo Beeps

- A. Upon gaining access to the installer menu (see section 5.1.1 points A to C) the display will read "SUPERVISION".  
 B. Press **<▶>** twice; **PIEZO BEEP** is displayed.  
 C. Press **<√>**.  
 D. Press **<▶>** to select between **enable beeps**, **off when home** and **disable beeps**.

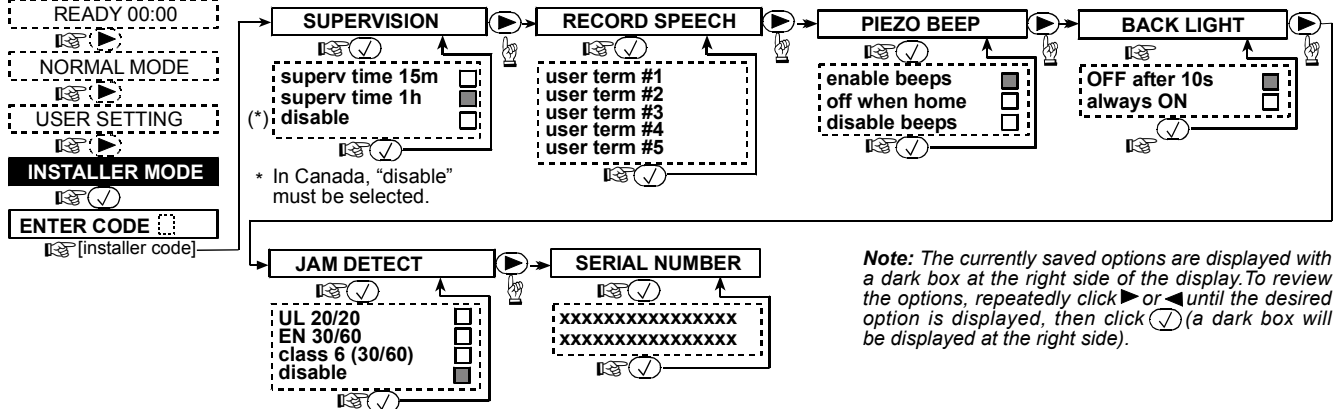

Figure 8: Defining MKP-150/MKP-151 Functions

## 5.2 User Setting Functions

The user settings on your MKP-150/MKP-151 keypad include the following functions (for instructions see *PowerMax+ User Guide*):

- Set Bypass
- Show Bypass
- Recall Bypass
- Set Phone Number
- Set User Codes
- Set Voice Option
- Auto Arm Option
- Auto Arm Time
- Squawk Option
- Light by Timer (for further details, see *PowerMax+ User Guide, Para. 4.5 Automatic ON/OFF Control*).
- Light by Sensor (for further details, see *PowerMax+ User Guide, Para. 4.5 Automatic ON/OFF Control*).

Make sure the system is not in Arm mode. The display should read:



- E. Press **<√>** to set the selected option.

### 5.1.4 Keypad Back Light

- A. Upon gaining access to the installer menu (see section 5.1.1 points A to C) the display will read "SUPERVISION".  
 B. Press **<▶>** repeatedly until **BACK LIGHT** is displayed.  
 C. Press **<√>**.  
 D. Press **<▶>** to select between **OFF after 10s** and **always ON**.  
 E. Press **<√>** to set the selected option.

### 5.1.5 Jam Detection

- A. Upon gaining access to the installer menu (see section 5.1.1 points A to C) the display will read "SUPERVISION".  
 B. Press **<▶>** repeatedly until **JAM DETECTION** is displayed.  
 C. Press **<√>**.  
 D. Press **<▶>** to select between **UL 20/20**, **EN 30/60**, **class 6 (30/60)**, **disable** and **other**.  
 E. Press **<√>** to set the selected option.

### 5.1.6 To Read the Device Serial Number

- A. Upon gaining access to the installer menu (see section 5.1.1 points A to C) the display will read "SUPERVISION".  
 B. Press **<▶>** repeatedly until **SERIAL NUMBER** is displayed.  
 C. Press **<√>** to read the serial number assigned to the unit.

Note: The currently saved options are displayed with a dark box at the right side of the display. To review the options, repeatedly click **<▶>** or **<◀>** until the desired option is displayed, then click **<√>** (a dark box will be displayed at the right side).

### TO SET FUNCTIONS

The user's menu is accessible only to those who know the master user code, which is **1→1→1→1** by factory default. Use this code for initial access, and replace it with a new code known only to you, (see *PowerMax+ User's Guide*).

- A. Press the **▶** button twice.

The display should read:

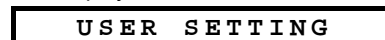

- B. Press the **√**. The display should read:



- C. Enter your code. The display will change to:



Note: If the bypass function is disabled, the display will change to:

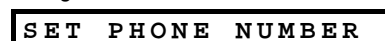

- D. Having gained access to the user's menu, you may now select any other item on the User Settings menu as detailed in Figure 9.



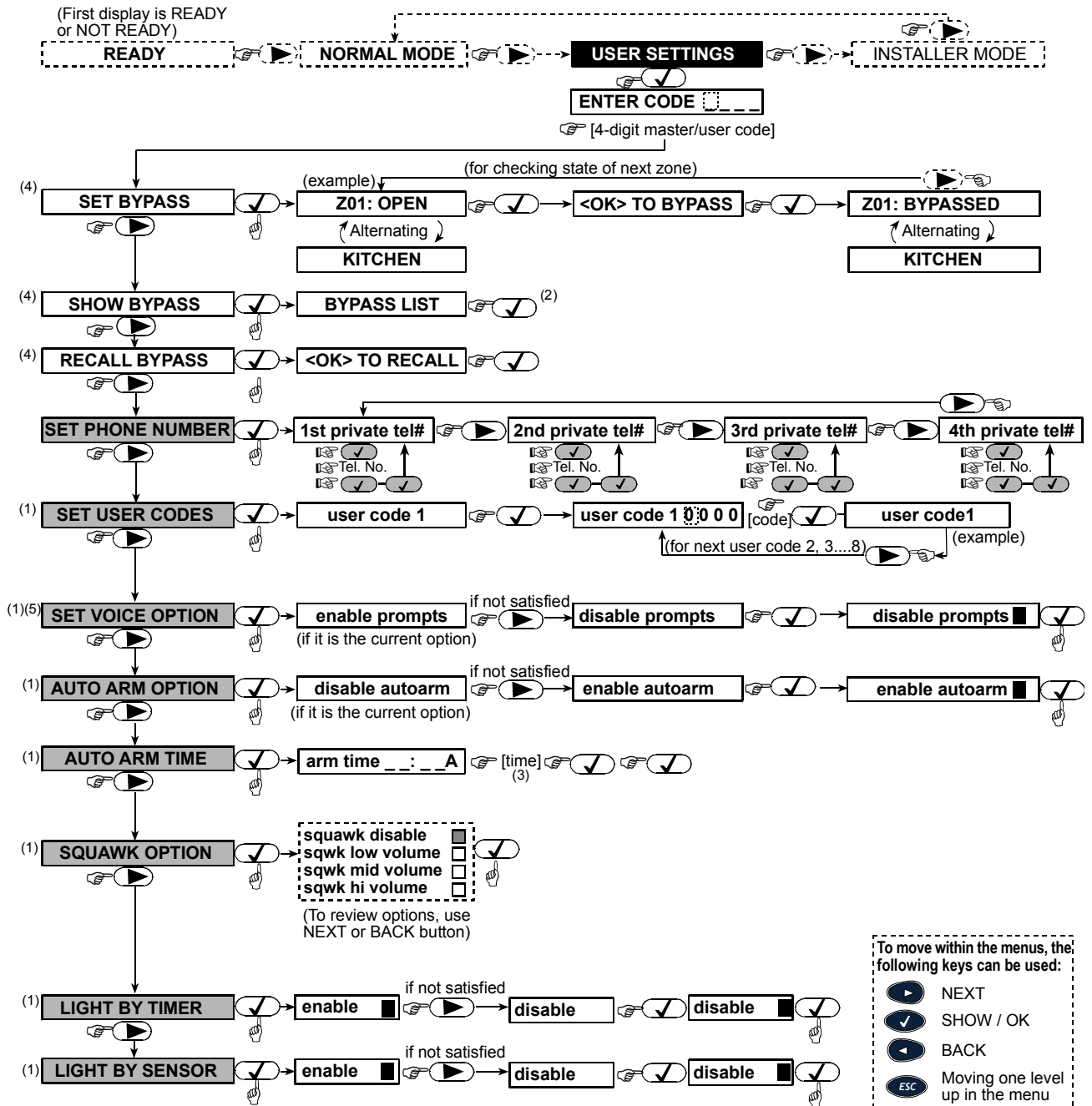

**NOTES**









- (1) Function inside black rectangles are accessible only if master user code was entered.
- (2) Press OK to display the number, state and name of first bypassed zone. Press NEXT/BACK repeatedly to view all the bypassed zones.
- (3) To enter "A" (AM) press [ ] ( or one of the 3 keys above it), to enter "P" (PM) press [ ] ( or one of the 3 keys above it). (Not functional if the time format has been set to the 24 hour clock via the PowerMax+.)
- (4) SET/SHOW/RECALL BYPASS menus are accessible only if "manual bypass" has been selected by the installer via the PowerMax+.
- (5) In the SET VOICE OPTION, if you select "enable prompts", the PowerMax+ mute speaker button [ ] is active.





Figure 9: User Settings Flow Chart

**6. OPERATION**

Function	Actions
Arming HOME	[ ] [user code] (1) (3)
Arming HOME INSTANT	[ ] [user code] (1) [ ]
Arming AWAY	[ ] [user code] (1)
Arming AWAY INSTANT	[ ] [user code] (1) [ ]
Forced Arming HOME	[ ] [user code] (1) [ ]

Forced Arming AWAY	[ ] [user code] (1) [ ]
Disarming	[ ] [user code] (1)
X-10 device (1-15) ON	[ ] unit # [1-15]
X-10 device (1-15) OFF	[ ] unit # [1-15]
Light dim / brightness	[ ] or [ ] unit # [1-15] [ ] or [ ]

<b>Emergency alarm</b>	 (≈ 2 sec.) <sup>(5)</sup>
<b>Fire alarm</b>	 (≈ 2 sec.) <sup>(5)</sup>
<b>Panic alarm</b>	
<b>Latchkey arming</b>	  <sup>(2)</sup>
<b>Quick arm / HOME / AWAY</b>	 (operates only if enabled in PowerMax+)
<b>Chime ON/OFF</b>	 (press again to select option)
<b>Local Recording</b>	 (press continuously while talking)
<b>Playback</b>	

<b>Local Voice On / Off</b>	
<b>Testing</b>	 [user code] <sup>(1) (3)</sup>
<b>Bypass</b>	 [user code] <sup>(1)</sup>
<b>Duress</b>	 [duress code] (2580 by default)

#### Notes

1. The factory default master user code is 1 1 1 1. The code is not required if **quick arming** has been permitted by the installer.
2. For LATCHKEY arming function, press the AWAY key, and then press the AWAY key again.
3. Pressing a non-valid code combination (not master / user code) causes a long failure beep.
4. If a keying sequence is not completed within a five second period, the desired function will not be executed.
5. Emergency, Fire or Panic buttons become active only if enabled in the PowerMax+.

## 7. COMPLIANCE WITH STANDARDS

This device complies with the essential requirements and provisions of Directive 1999/5/EC of the European Parliament and of the Council of 9 March 1999 on radio and telecommunications terminal equipment.

#### Frequency Allocations for Wireless Devices in European Countries:

- 315 MHz is not allowed in any EU member state.
- 433.92 MHz has no restriction in any EU member state.
- 868.95 MHz (wide band) is allowed in all EU member states.
- 869.2625 MHz (narrow band) is not restricted in any EU member state.

The user is cautioned that changes or modifications to the unit, not expressly approved by Visonic Ltd., could void the user's FCC or other authority to operate the equipment.

The 315 MHz model of this device complies with Part 15 of the FCC Rules and RSS-210 of Industry and Science Canada. Operation is subject to these two conditions: (1) This device may not cause harmful interference, and (2) this device must accept any interference received, including interference that may cause undesirable operation.

The digital circuit of this device had been tested and found to comply with the limits for a Class B digital device, pursuant to Part 15 of the FCC rules. These limits are designed to provide reasonable protection against harmful interference in residential installations. This equipment generates, uses, and can radiate radio frequency energy and, if not installed and used in accordance with the instructions, may cause harmful interference to radio and television reception. However, there is no guarantee that interference will not occur in a particular installation. If this device does cause such interference, which can be verified by turning the device off and on, the user is encouraged to eliminate the interference by one or more of the following measures:

- Re-orient or re-locate the receiving antenna.
- Increase the distance between the device and the receiver.
- Connect the device to an outlet on a circuit different from the one which supplies power to the receiver.
- Consult the dealer or an experienced radio/TV technician.

### WARRANTY

Visonic Ltd. and/or its subsidiaries and its affiliates ("the Manufacturer") warrants its products hereinafter referred to as "the Product" or "Products" to be in conformance with its own plans and specifications and to be free of defects in materials and workmanship under normal use and service for a period of twelve months from the date of shipment by the Manufacturer. The Manufacturer's obligations shall be limited within the warranty period, at its option, to repair or replace the product or any part thereof. The Manufacturer shall not be responsible for dismantling and/or reinstallation charges. To exercise the warranty the product must be returned to the Manufacturer freight prepaid and insured.

**This warranty does not apply in the following cases:** improper installation, misuse, failure to follow installation and operating instructions, alteration, abuse, accident or tampering, and repair by anyone other than the Manufacturer.

This warranty is exclusive and expressly in lieu of all other warranties, obligations or liabilities, whether written, oral, express or implied, including any warranty of merchantability or fitness for a particular purpose, or otherwise. In no case shall the Manufacturer be liable to anyone for any consequential or incidental damages for breach of this warranty or any other warranties whatsoever, as aforesaid.

This warranty shall not be modified, varied or extended, and the Manufacturer does not authorize any person to act on its behalf in the modification, variation or extension of this warranty. This warranty shall apply to the Product only. All products, accessories or attachments of others used in conjunction with the Product, including batteries, shall be covered solely by their own warranty, if any. The Manufacturer shall not be liable for any damage or loss whatsoever, whether directly, indirectly, incidentally, consequentially or otherwise, caused by the malfunction of the Product due to products, accessories, or attachments of others, including batteries, used in conjunction with the Products.

The Manufacturer does not represent that its Product may not be compromised and/or circumvented, or that the Product will prevent any death, personal and/or bodily injury and/or damage to property resulting from burglary, robbery, fire or otherwise, or that the Product will in all cases provide adequate warning or protection. User understands that a properly installed and maintained alarm may only reduce the risk of events such as burglary, robbery, and fire without warning, but it is not insurance or a guarantee that such will not occur or that there will be no death, personal damage and/or damage to property as a result.

**The Manufacturer shall have no liability for any death, personal and/or bodily injury and/or damage to property or other loss whether direct, indirect, incidental, consequential or otherwise, based on a claim that the Product failed to function.** However, if the Manufacturer is held liable, whether directly or indirectly, for any loss or damage arising under this limited warranty or otherwise, regardless of cause or origin, the Manufacturer's maximum liability shall not in any case exceed the purchase price of the Product, which shall be fixed as liquidated damages and not as a penalty, and shall be the complete and exclusive remedy against the Manufacturer.

**Warning:** The user should follow the installation and operation instructions and among other things test the Product and the whole system at least once a week. For various reasons, including, but not limited to, changes in environmental conditions, electric or electronic disruptions and tampering, the Product may not perform as expected. The user is advised to take all necessary precautions for his/her safety and the protection of his/her property.

6/91



#### W.E.E. Product Recycling Declaration

For information regarding the recycling of this product you must contact the company from which you originally purchased it. If you are discarding this product and not returning it for repair then you must ensure that it is returned as identified by your supplier. **This product is not to be thrown away with everyday waste.** Directive 2002/96/EC Waste Electrical and Electronic Equipment.



VISONIC LTD. (ISRAEL): P.O.B 22020 TEL-AVIV 61220 ISRAEL. PHONE: (972-3) 645-6789, FAX: (972-3) 645-6788  
 VISONIC INC. (U.S.A.): 65 WEST DUDLEY TOWN ROAD, BLOOMFIELD CT. 06002-1376. PHONE: (860) 243-0833, (800) 223-0020. FAX: (860) 242-8094  
 VISONIC LTD. (UK): FRASER ROAD, PRIORY BUSINESS PARK, BEDFORD MK44 3WH. PHONE: (0870) 7300800 FAX: (0870) 7300801  
 INTERNET: www.visonic.com  
 ©VISONIC LTD. 2007 MKP-150, MKP-151 DE2462U (REV. 2, 10/07)



MADE IN ISRAEL